

**CPX 50-12**

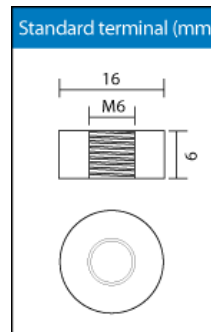
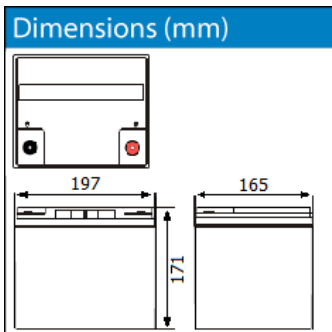

Nominal voltage	12 V DC	
Nominal Capacity (5HR, 20°C):	46 Ah	
Nominal Capacity (10HR, 20°C):	47 Ah	
Nominal Capacity (20HR, 20°C):	50 Ah	
Internal resistance	Approx. 6 m Ω	
Maximum charging current	15.00 A	
Maximum discharge current	750 A (5 sec.)	
Number of cycles	800 (50% D.O.D.)	
Operating temperature range	-20°C ~ 50°C	
Float use/ cycle use	13.5 – 13.8V/ 14.4 – 15.0V	
Standard terminal	Threaded Insert 6mm	
Housing material	ABS	
Dimensions	length	197 mm
	width	165 mm
	height	171 mm (±1 mm)
Approx. Weight	16.50 kg	
Packing	1 pcs/box	

**Typical applications:**

- Electric Vehicle
- Electric Wheelchairs
- E-bike
- Lawn mowers
- Golf-Carts
- Medical Equipment
- Boats

- Valve Regulated Maintenance Free
- Absorbent Glassmat Technology
- Complies with IEC61056, JIS C 8702, GB/T 19639
- Low self discharge
- Classified as non- spillable and Non Dangerous goods by IATA, FAA, ADR, IMDG
- Can be used in any orientation
- Cannot be charged while the terminal is downward.

Charging characteristics

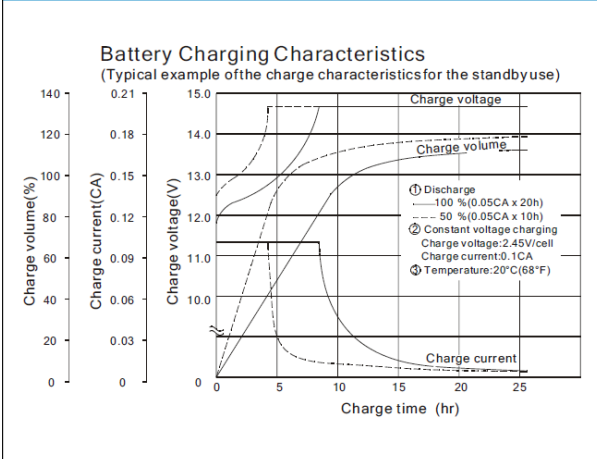

Discharge characteristics curves

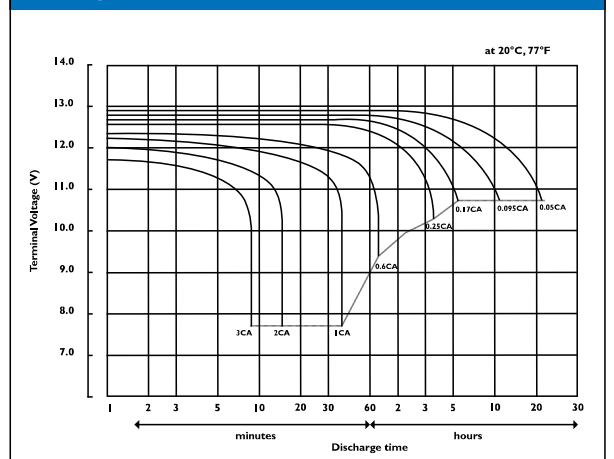

Relationship between charging voltage and temperature

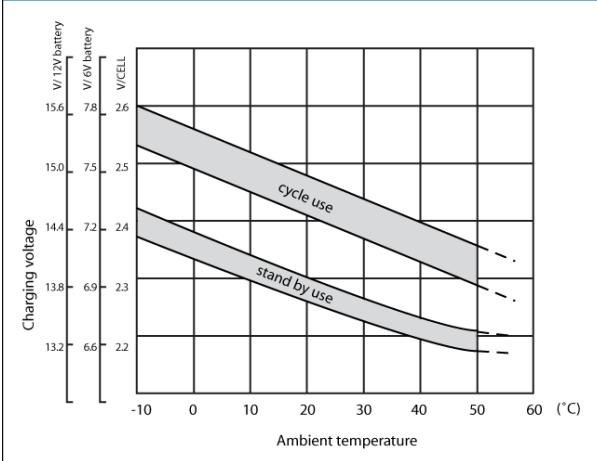

Cycle service life in relation to depth and discharge

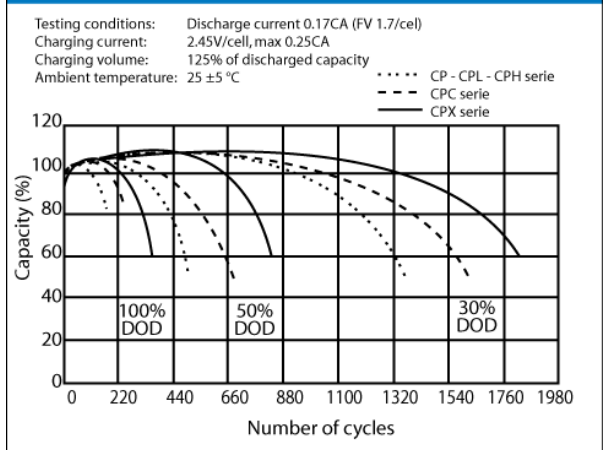

Models available

Model	capacity (Ah)	Dimensions (mm)	Weight (kg)
CPX 20 - 12	20	181 x 76 x 166	6.45
CPX 26 - 12	26	175 x 166 x 125	9.60
CPX 33 - 12	33	195 x 129 x 166	11.50
CPX 50 - 12	50	197 x 165 x 171	16.50
CPX 80 - 12	80	261 x 173 x 215.5	26.00
CPX 90 - 12	90	306 x 173 x 215.5	29.80
CPX 110 - 12	110	330 x 173 x 227.5	34.30